

SEZIONE A-A

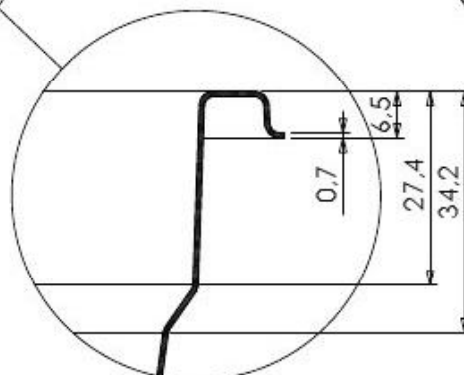

DETTAGLIO

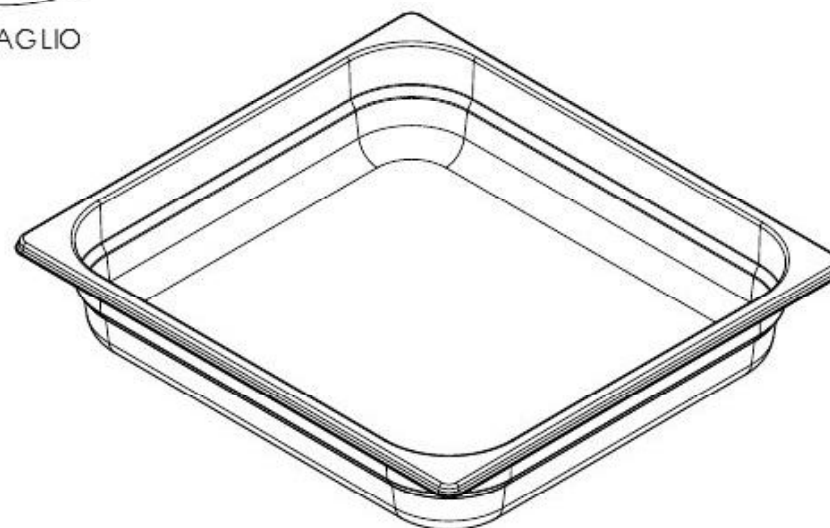
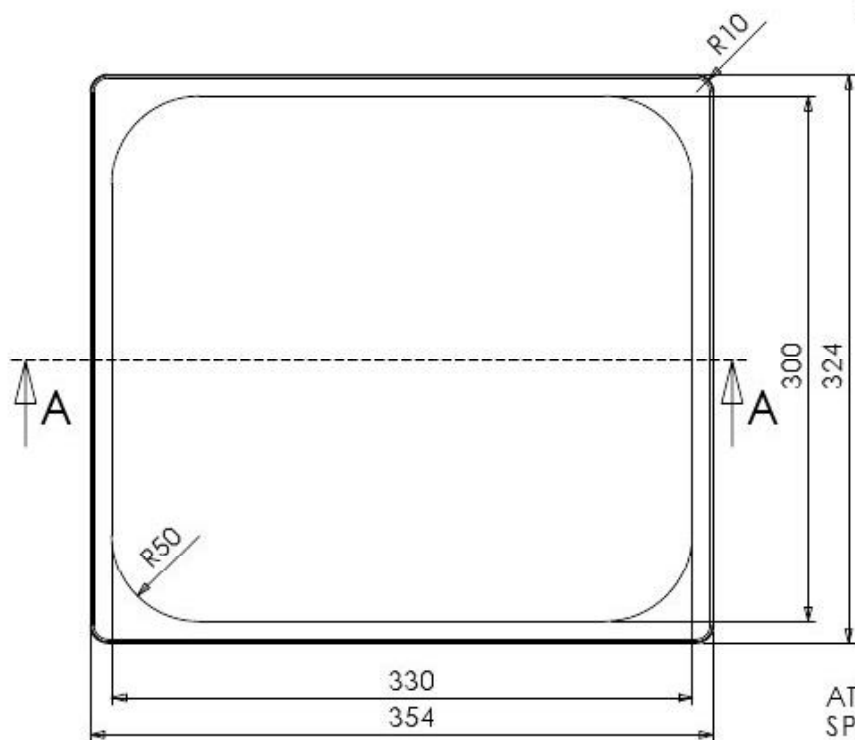
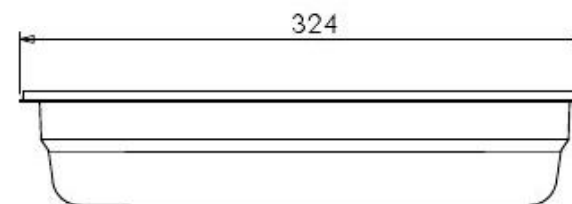

ATTENZIONE:
SP. 0.7 mm

TOLLERANZA +/- 1 mm

GASTRONORM 2/3x065

NR. DISEGNO	
DATA:	12/04/2010
MATERIALE:	AISI 304
CLIENTE:	



SCALA: 1:4

FOGLIO 1 OF 1